



DRŽAČI ALATA





P010	Držač alata s navojem	4
P014	Držač alata s navojem	
P016	Držač alata s navojem	5
P034	Držač alata s navojem	
P040A	Adapter za svrdlo	6
P040B	Adapter za svrdlo	
P040C	Adapter za svrdlo	7
P040D	Adapter za svrdlo	
P040E	Adapter za svrdlo	8
P040F	Adapter za svrdlo	
P040H	Adapter za svrdlo	9
P041	Reducir prsten za spiralno svrdlo	
P040G	Brzoizmjenjivi adapter	10
P040I	Brzoizmjenjivi adapter	
P040L	Brzoizmjenjivi adapter	11
P040M	Brzoizmjenjivi adapter	
P040N	Brzoizmjenjivi adapter	12
P040P	Brzoizmjenjivi adapter	
P231PI	Precizna elastična čahura DIN6499	13
P233PI	Precizna elastična čahura DIN6499	
P234PI	Precizna elastična čahura DIN6499	14
P235PI	Precizna elastična čahura DIN6388	
P238PI	Precizna elastična čahura	15
P700	Držač alata SK30 DIN 69871	16
P701	Držač alata SK30	
P702	Držač alata SK30	17
P703	Držač alata SK30	
P705	Držač alata SK30 s nazubljenom glavčinom	18
P707	Držač alata SK40 DIN69871	
P709	Trn s elastičnom čahurom ER40	19
P720	Držač alata HSK 63F DIN69893	
P722	Držač alata HSK 63E DIN69893	20
P730	Stezna matica	21
P735	Stezna matica s ležajem	
P740	Stezna matica	
P750	Trn SK30 DIN69871	22
P751	Trn SK30	
P752	Trn SK30	23
P755	Trn SK30 s nazubljenom glavčinom	
P757	Trn SK40 DIN69871	24
P759	Trn ER40	
P760	Trn HSK 63F DIN69893	25
P762	Trn HSK 63E DIN69893	
P765	Trn HSK 85 POWER LOCK	26
P768	Trn HSK 85 POWER LOCK	
P774	Držač alata s hidro sistemom HSK 63F	27
P784	Držač alata s hidro sistemom HSK 63F	
P786	Držač alata s hidro sistemom WEINIG HSK 85 POWER LOCK	28



P800	Prihvatni vijak za trnove i držače alata	29
B020	Reducir prsten	30
B030	Reducir prsten s prirubnicom i maticom	31
B040	Reducir prsten s prirubnicom	
B050	Prirubnica za stezanje kružnih pila	32
B060	Prirubnica za stezanje kružnih pila sa smanjenim promjerom	
B110B	Stezna čahura s hidro sistemom za stezanje glodala	33
A010	Distantni prsten	34
CH	Kukasti ključ	35
CHET	Šesterokutni odvijač s «T» ručkom, «IMBUS»	
CHTC	Torx odvijač s ručkom	
CHTT	Torx odvijač s «T» ručkom	

P010

Držač alata s navojem

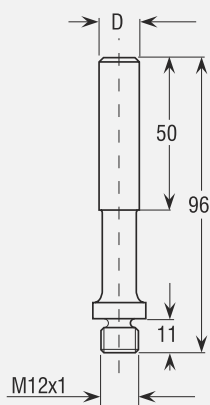
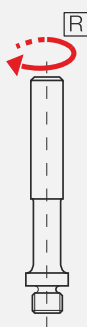

Može se koristiti u kombinaciji s artiklom P160.

D	Cod. L	Cod.R	Cijena
13	P01013L	P01013R	
Spec.	P01099L*	P01099R*	

Držač s istim dimenzijama ali s D=16 vodi se pod šifrom P012

P014

Držač alata s navojem

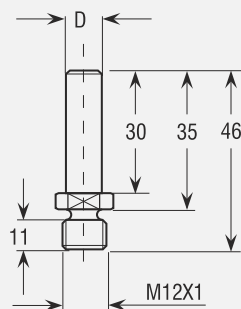
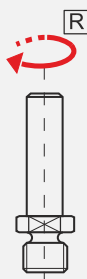

Može se koristiti u kombinaciji s artiklom P160.

D	Cod.	Cijena
8	P0148	
9,5	P01495	
12	P01412	
Spec.	P01499*	

P016

Držač alata s navojem

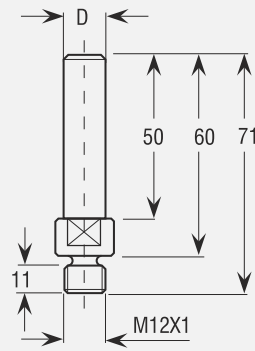

Može se koristiti u kombinaciji s artiklom P160.



D	Cod.	Cijena
10	P01610	
Spec.	P01699*	

P034

Držač alata s navojem

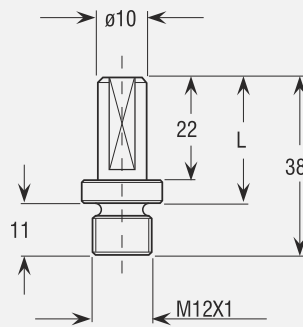

Može se koristiti u kombinaciji s artiklom P160.

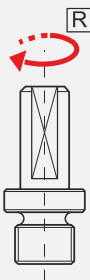

L	Cod. L	Cod. R	Cijena
27	P034L	P034R	
Spec.	P03499L*	P03499R*	

P040A

Adapter za svrdlo

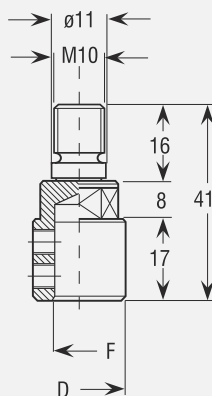

Koristi se na strojevima:
ALBERTI • BALESTRINI • BIESSE • BUSELLATO • GESSNERMORBI
DELLI • REIMALL • TORWEGGE • VITAP • WEEKE.

F	D	Cod. L	Cod. R	Cijena
8	16	P0408AL	P0408AR	
10	19	P04010AL	P04010AR	
Spec.		P040A99L*	P040A99R*	



P040B

Adapter za svrdlo

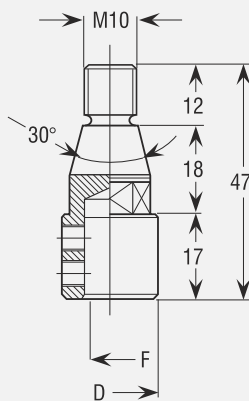

Koristi se na strojevima:
ALBERTI • BALESTRINI • BILEK • BUSELLATO • OMPEC • REIMALL
• SCHLICHER • SCM • TANZANI • VITAP • VICIANI • WEINGARTER.

F	D	Cod. L	Cod. R	Cijena
8	16	P0408BL	P0408BR	
10	19	P04010BL	P04010BR	
Spec.		P040B99L*	P040B99R*	



P040C

Adapter za svrdlo

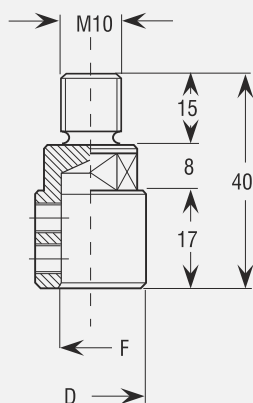

Koristi se na strojevima:
AYEN • HOLZMA • KNOEVENAGEL • MAYER • TORWEGGE.

F	D	Cod. L	Cod. R	Cijena
8	16	P0408CL	P0408CR	
10	19	P04010CL	P04010CR	
Spec.		P040C99L*	P040C99R*	

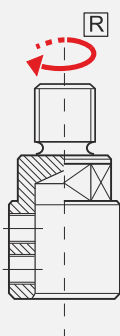

P040D

Adapter za svrdlo

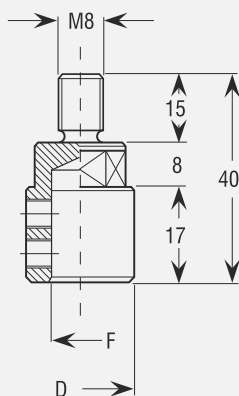

Koristi se na strojevima:
NOTTMEYER.

F	D	Cod. L	Cod. R	Cijena
8	15,5	P0408DL	P0408DR	
10	19	P04010DL	P04010DR	
Spec.		P040D99L*	P040D99R*	

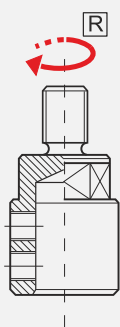

P040E

Adapter za svrdlo

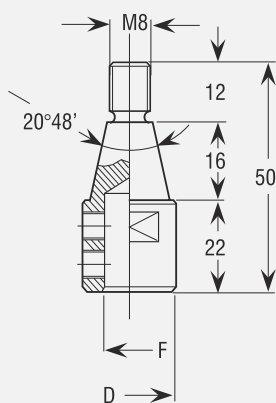

Koristi se na strojevima:
BILEK • KNOEVENAGEL.

F	D	Cod. L	Cod. R	Cijena
8	15,5	P0408EL	P0408ER	
10	19	P04010EL	P04010ER	
Spec.		P040E99L*	P040E99R*	



P040F

Adapter za svrdlo

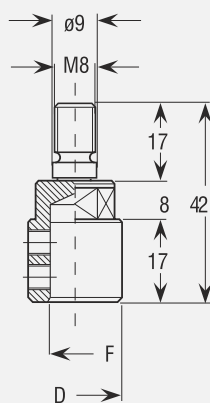

Koristi se na strojevima:
MORBIDELLI • NOTTMEYER • ZANGHERI • BOSCHETTI.

F	D	Cod. L	Cod. R	Cijena
8	15,5	P0408FL	P0408FR	
10	19	P04010FL	P04010FR	
Spec.		P040F99L*	P040F99R*	

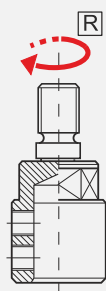

P040H

Adapter za svrdlo

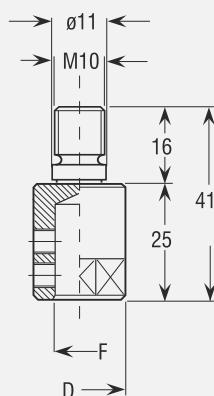

Koristi se na strojevima:
ALBERTI • BALESTRINI • BIESSE • BUSELLATO • GESSNER-
MORBIDELLI • REIMALL • TORWEGGE • VITAP • WEEKE.

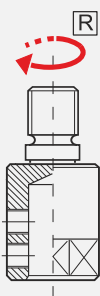

F	D	Cod. L	Cod. R	Cijena
10	19	P04010HL	P04010HR	
Spec.		P040H99L*	P040H99R*	

P041

Reducir prsten za spiralno svrdlo

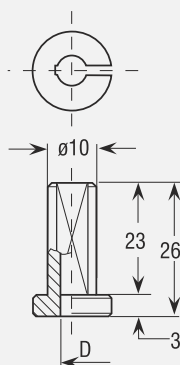

Koristi se u kombinaciji s artiklima P104-P105-P107-P109 na
reducir adapteru P040.

Primjer montaže

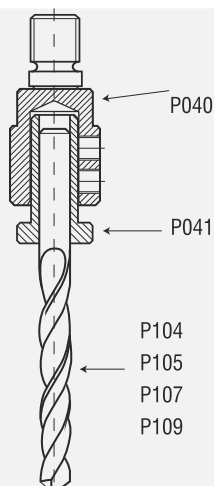

D	Cod.	Cijena
2	P0412	
2,5	P04125	
3	P0413	
3,2	P04132	
3,5	P04135	
4	P0414	
4,5	P04145	
5	P0415	
5,5	P04155	
6	P0416	
6,5	P04165	
7	P0417	
7,5	P04175	
8	P0418	
Spec.	P04199*	

P040G

Brzoizmjenjivi adapter

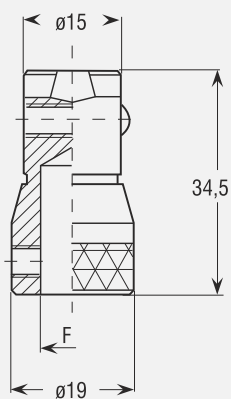

Koristi se na strojevima:
BUSELLATO.

F	Cod.	Cijena
10	P04010GR	
Spec.	P040G99*	

P040I

Brzoizmjenjivi adapter

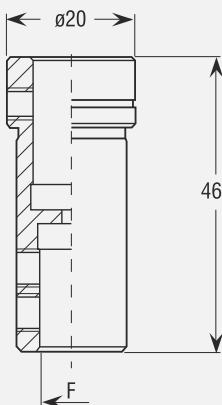

Koristi se na strojevima:
WEEKE.

F	Cod.	Cijena
10	P04010IR	
Spec.	P040I99*	

DRŽAČI ALATA

9

P040L

Brzoizmjenjivi adapter

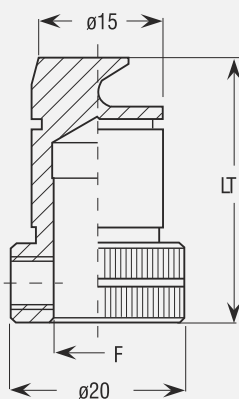

Koristi se na strojevima:
BIESSE.

F	LT	Cod.	Cijena
10	30	P04010LR	
10	37	P04010LR37	
Spec.		P040L99*	

P040M

Brzoizmjenjivi adapter

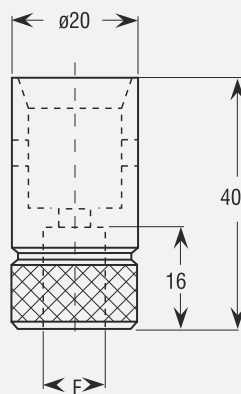

Koristi se na strojevima:
MAGGI • MASTEWOOD • GRIGGIO.

F	Cod.	Cijena
10	P04010MR	
Spec.	P040M99*	

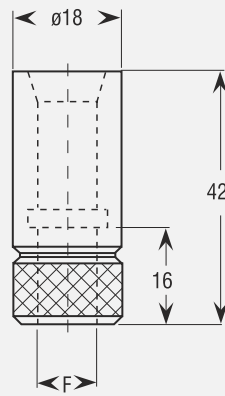
P040N**Brzoizmjenjivi adapter**

Koristi se na strojevima:
VITAP.

F	Cod.	Cijena
10	P04010NR	
Spec.	P040N99*	

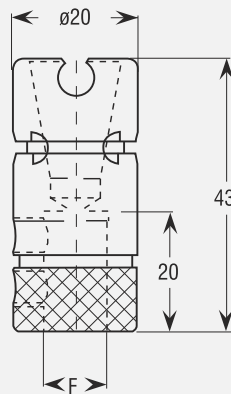
P040P**Brzoizmjenjivi adapter**

Koristi se na strojevima:
MORBIDELLI.

F	Cod.	Cijena
10	P04010PR	
Spec.	P040P99*	

P231PI

Precizna elastična čahura DIN6499

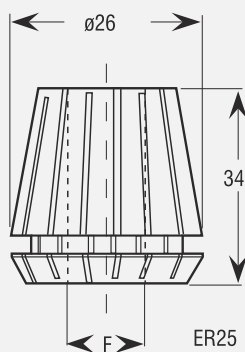

Koristi se u kombinaciji s artiklom P709.

D	Cod.	Cijena
5-4	P231PI5	
6-5	P231PI6	
7-6	P231PI7	
8-7	P231PI8	
9-8	P231PI9	
10-9	P231PI10	
11-10	P231PI11	
12-11	P231PI12	
13-12	P231PI13	
14-13	P231PI14	
16-15	P231PI16	
Spec.	P231PI99*	

P233PI

Precizna elastična čahura DIN6499

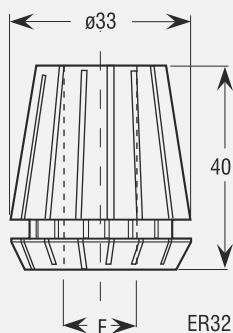

Koristi se u kombinaciji s artiklom P700-P701-P702-P703-P705-P720-P722-P726.

F	Cod.	Cijena
3-2	P233PI3	
4-3	P233PI4	
5-4	P233PI5	
6-5	P233PI6	
7-6	P233PI7	
8-7	P233PI8	
9-8	P233PI9	
3/8"	P233PI95	
10-9	P233PI10	
12-11	P233PI12	
13-12	P233PI13	
14-13	P233PI14	
16-15	P233PI16	
18-17	P233PI18	
20-19	P233PI20	
Spec.	P233PI99*	

P234PI

Precizna elastična čahura DIN6499

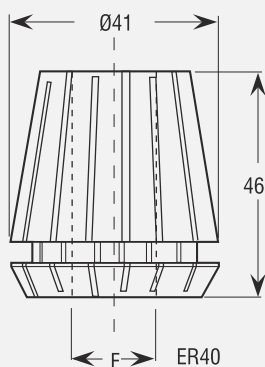

Koristi se u kombinaciji s artiklom P700-P701-P702-P703-P705-P707-P720-P722.

F	Cod.	Cijena
4-3	P234PI4	
5-4	P234PI5	
6-5	P234PI6	
8-7	P234PI8	
10-9	P234PI10	
12-11	P234PI12	
14-13	P234PI14	
16-15	P234PI16	
18-17	P234PI18	
20-19	P234PI20	
25-14	P234PI25	
30	P234PI30	
Spec.	P234PI99*	

P235PI

Precizna elastična čahura DIN6388

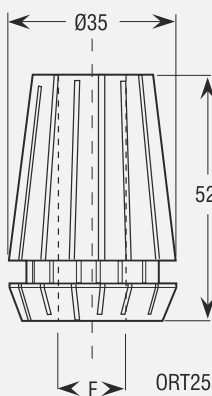

Koristi se u kombinaciji s artiklom P700-P701-P702-P703-P705-P707-P720-P722.

F	Cod.	Cijena
4-3	P235PI4	
5-4	P235PI5	
6-5	P235PI6	
8-7	P235PI8	
9,5-8,5	P235PI95	
10-9	P235PI10	
12-11	P235PI12	
14-13	P235PI14	
16-15	P235PI16	
18-17	P235PI18	
20-19	P235PI20	
25-24	P235PI25	
Spec.	P235PI99*	

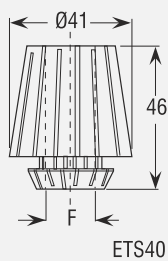
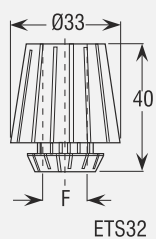

Koristi se u kombinaciji s artiklom P700-P701-P702-P703 - P705-P707-P720-P722-P726.

F	Cod.	Cijena
4-3	P238PI4ETS32	
6-5	P238PI6ETS32	
8-7	P238PI8ETS32	
10-9	P238PI10ETS32	
12-11	P238PI12ETS32	
14-13	P238PI14ETS32	
16-15	P238PI16ETS32	
18-17	P238PI18ETS32	
20-19	P238PI20ETS32	

4-3	P238PI4ETS40	Cijena
6-5	P238PI6ETS40	
8-7	P238PI8ETS40	
10-9	P238PI10ETS40	
12-11	P238PI12ETS40	
14-13	P238PI14ETS40	
16-15	P238PI16ETS40	
18-17	P238PI18ETS40	
20-19	P238PI20ETS40	
Spec.	P238PI99*	

P700

Držač alata SK30 DIN 69871

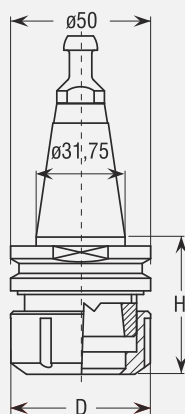

Koristi se na strojevima: BIESSE u kombinaciji s artiklom P233PI-P234PI-P235PI.

D	H	El. čahura	Cod. L	Cijena	Cod. R	Cijena
50	49	ER32	P700L3250		P700R3250	
63	57	ER40	P700L4057		P700R4057	
60	57	ORT25	P700L2557		P700R2557	
Spec.			P70099L*		P70099R*	

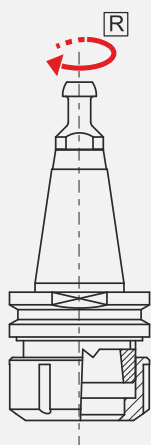

P701

Držač alata SK30

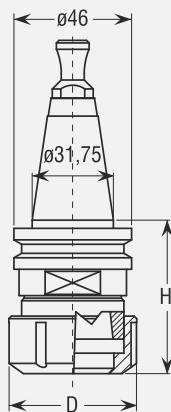

Koristi se na strojevima: CMS u kombinaciji s artiklom P233PI-P234PI-P235PI.

D	H	El. čahura	Cod. L	Cijena	Cod. R	Cijena
50	60	ER32	P701L3260		P701R3260	
63	65	ER40	P701L4065		P701R4065	
60	70	ORT25	P701L2570		P701R2570	
Spec.			P70199L*		P70199R*	

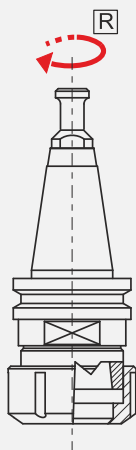

P702

Držač alata SK30

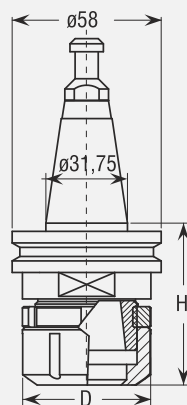

Koristi se na strojevima: ESSETEAM, UNITEAM u kombinaciji s artiklom P233PI-P234PI-P235PI.

D	H	El. čahura	Cod. L	Cijena	Cod. R	Cijena
50	63	ER32	P702L3263		P702R3263	
63	65	ER40	P702L4065		P702R4065	
Spec.			P70299L*		P70299R*	

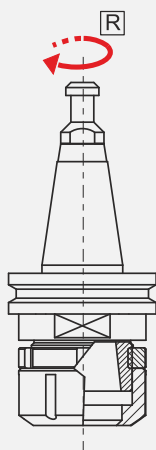

P703

Držač alata SK30

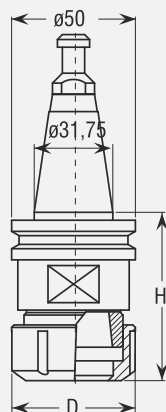

Koristi se na strojevima: WEEKE u kombinaciji s artiklom P233PI-P234PI-P235PI.

D	H	El. čahura	Cod. L	Cijena	Cod. R	Cijena
50	68	ER32	P703L3268		P703R3268	
63	68	ER40	P703L4068		P703R4068	
60	70	ORT25	P703L2570		P703R2570	
Spec.			P70399L*		P70399R*	

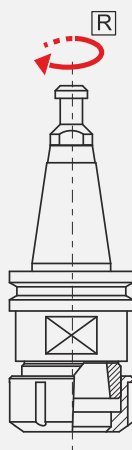

P705

Držač alata SK30 s nazubljenom glavčinom

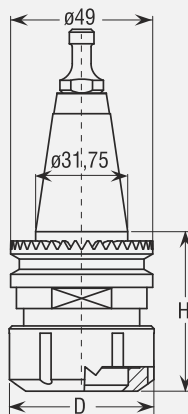

Koristi se u kombinaciji s artiklom P233PI-P234PI-P235PI na strojevima: SCM i MORBIDELLI

D	H	El. čahura	Cod. L	Cijena	Cod. R	Cijena
60	55	ER32	P705L3255		P705R3255	
63	72	ER40	P705L4072		P705R4072	
60	72	ORT25	P705L2572		P705R2572	
Spec.			P70599L*		P70599R*	

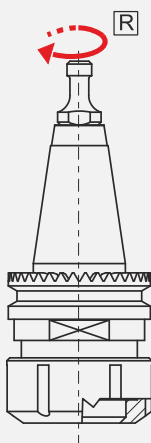

P707

Držač alata SK40 DIN69871

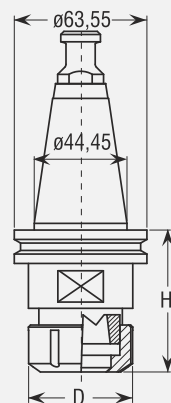

Koristi se u kombinaciji s artiklom P234PI-P235PI na strojevima: IMA, MAKA, REICHEMBACHER, STEGHERR, WEEKE.

D	H	El. čahura	Cod. L	Cijena	Cod. R	Cijena
63	68	ER40	P707L4068		P707R4068	
60	74	ORT25	P707L2574		P707R2574	
Spec.			P70799L*		P70799R*	

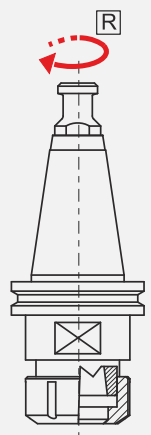

P709



Trn s elastičnom čahurom ER40



Koristi se u kombinaciji s artiklom P231PI na strojevima: BACCI.

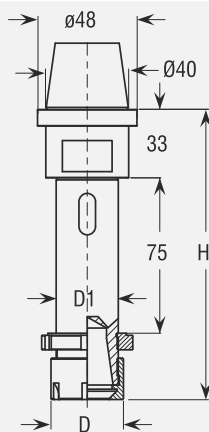

D	D1	H	Cod. L	Cijena	Cod. R	Cijena
35	30	140	P709L25		P709R25	
Spec.			P70999L*		P70999R*	

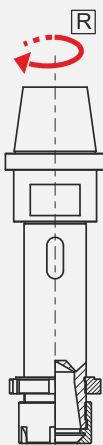

P720



Držač alata HSK 63F DIN69893



Koristi se u kombinaciji s artiklom P233PI, P234PI, P235PI na strojevima: BIESSE, IMA, MASTERWOOD, MORBIDELLI, SCM, WEEKE.

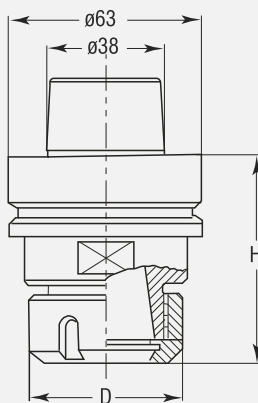

D	H	El. čahura	Cod. L	Cijena	Cod. R	Cijena
50	73	ER32	P720L32		P720R32	
63	76	ER40	P720L40		P720R40	
60	76	ORT25	P720L25		P720R25	
Spec.			P72099L*		P72099R*	

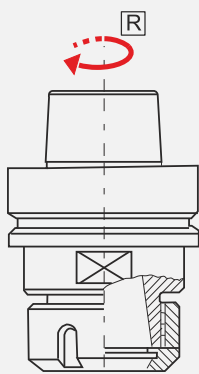

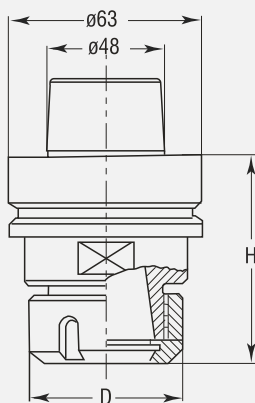

Koristi se u kombinaciji s artiklom P233PI, P234PI, P235PI na strojevima: CMS.

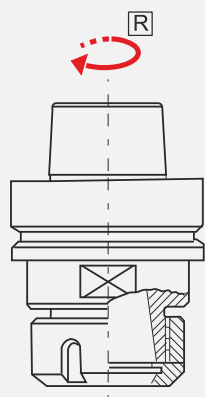

D	H	El. čahura	Cod. L	Cijena	Cod. R	Cijena
50	78	ER32	P722L32		P722R32	
63	78	ER40	P722L40		P722R40	
Spec.			P72299L*		P72299R*	

P730

Stezna matica

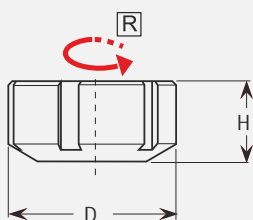

Čahura	D	H	Cod. L	Cijena	Cod.R	Cijena
ER25	35	20	P730L25		P730R25	
ER32	50	22,5	P730L32		P730R32	
ER32ETS	50	22,5	P730L32ETS		P730R32ETS	
ER40	63	25,5	P730L40		P730R40	
ER40ETS	63	25,5	P730L40ETS		P730R40ETS	
ORT25	60	30	P730L6388		P730R6388	
Spec.			P73099L*		P73099R*	

P735

Stezna matica s ležajem

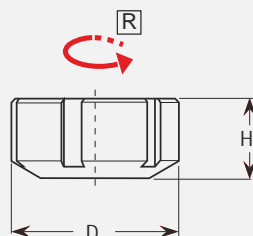

Čahura	D	H	Cod. L	Cijena	Cod. R	Cijena
ER32	50	22,5	P735L32		P735R32	
ER40	63	25,5	P735L40		P735R40	
ORT25	60	30	P735L25		P735R25	
Spec.			P73599L*		P73599R*	

P740

Stezna matica

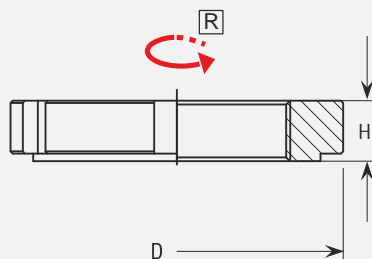

D	H	Cod. L	Cijena	Cod. R	Cijena
44	8	P740L		P740R	
Spec.		P74099L*		P74099R*	

P750

Trn SK30 DIN69871

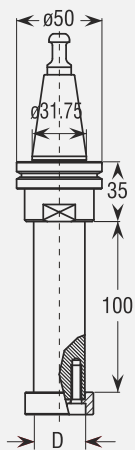

Koristi se na strojevima: BIESSE.
Za prihvat alata s provrtom.

D	Cod.	Cijena
30	P75030100	
Spec.	P75099*	

P751

Trn SK30

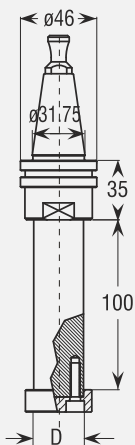

Koristi se na strojevima: CMS.
Za prihvat alata s provrtom.

D	Cod.	Cijena
30	P75130100	
Spec.	P75199*	

P752

Trn SK30

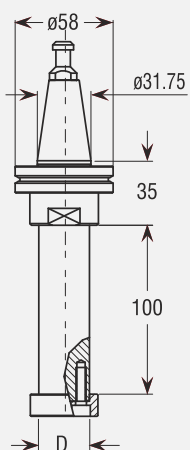

Koristi se na strojevima: ESSETEAM.
Za prihvat alata s provrtom.

D	Cod.	Cijena
30	P75230100	
Spec.	P75299*	

P755

Trn SK30 s nazubljenom glavčinom

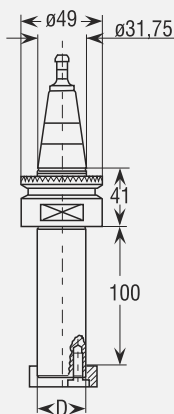

Koristi se na strojevima: MORBIDELLI i SCM.
Za prihvat alata s provrtom.

D	Cod.	Cijena
30	P75530100	
Spec.	P75599*	

P757

Trn SK40 DIN69871

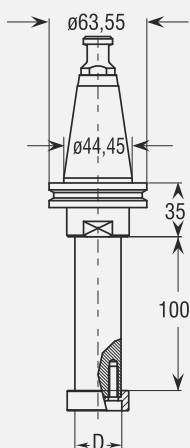

Koristi se na strojevima: IMA-MAKA-REICHENBACHER-SCM-STEGHER-WEEKE.
Za prihvat alata s provrtom.

D	Cod.	Cijena
30	P75730100	
35	P75735100	
40	P75740100	
Spec.	P75799*	

P759

Trn ER40

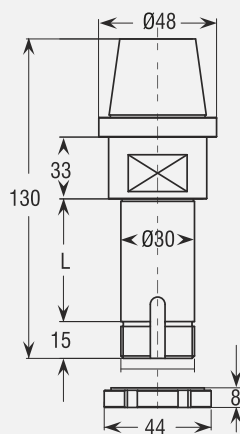

Koristi se na strojevima: BACCI.
Za prihvat alata s provrtom.

D	D1	H	Cod. L	Cijena	Cod.R	Cijena
30	44	50	P7593050L		P7593050R	
Spec.			P75999L*		P75999R*	

P760



Trn HSK 63F DIN69893

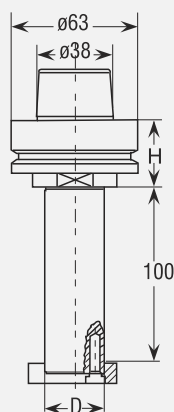

Koristi se na strojevima: BIESSE - IMA - MASTERWOOD - MORBIDELLI - SCM - WEEKE.
Za prihvat alata s provrtom.

D	H	Cod.	Cijena
30	33	P760F3330100	
30	42	P760F4230100	
35	33	P760F3335100	
35	42	P760F4235100	
40	33	P760F3340100	
40	42	P760F4240100	
Spec.		P760F99*	

P762



Trn HSK 63E DIN69893

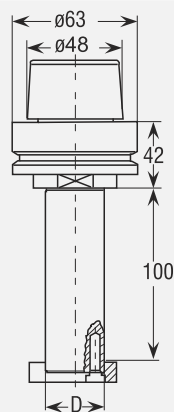

Koristi se na strojevima: CMS.
Za prihvat alata s provrtom.

D	Cod.	Cijena
30	P762E4230100	
35	P762E4235100	
40	P762E4240100	
Spec.	P762E99*	

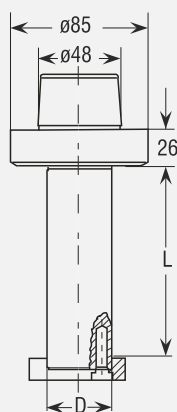
P765**Trn HSK 85 POWER LOCK**

Koristi se na strojevima: WEINIG.
Za prihvata alata s provrtom.

D	H	Cod.	Cijena
30	100	P76530100	
30	130	P76530130	
30	150	P76530150	
30	200	P76530200	
35	100	P76535100	
35	150	P76535150	
35	200	P76535200	
40	100	P76540100	
40	150	P76540150	
40	200	P76540200	
40	240	P76540240	
Spec.		P76599*	

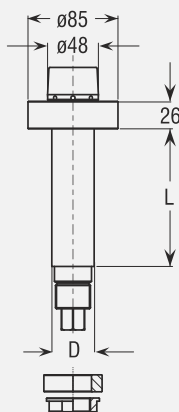
P768**Trn HSK 85 POWER LOCK**

Koristi se na strojevima: WEINIG.
Za prihvat alata s provrtom.

D	H	Cod.	Cijena
40	130	P76840130	
40	170	P76840170	
40	240	P76840240	
50	170	P76850170	
50	240	P76850240	
Spec.		P76899*	

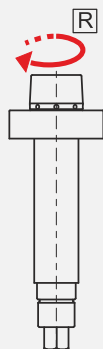

P774

Držač alata s hidro sistemom HSK 63F



Za prihvat alata s drškom.

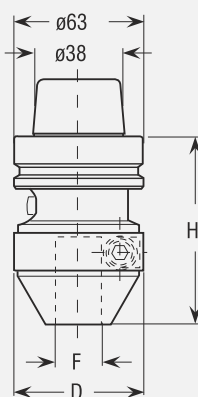

F	D	H	Cod.	Cijena
12	55	68	P77412	
16	58	74	P77416	
20	63	80	P77420	
25	67	87,5	P77425	
Spec.			P77499*	

P784

Držač alata s hidro sistemom HSK 63F



Za prihvat alata s provrtom.

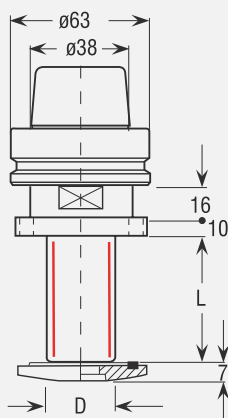

D	L	Cod.	Cijena
20	40	P7842040	
25	55	P7842555	
30	40	P7843040	
30	55	P7843055	
30	80	P7843080	
30	100	P78430100	
Spec.		P78499*	

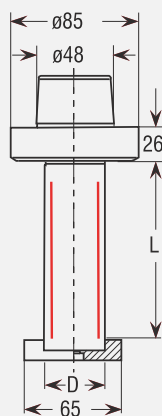

Za prihvat alata s provrtom.
Koristi se na strojevima: WEINIG.

D	L	Cod.	Cijena
30	55	P7863055	
30	100	P78630100	
40	55	P7864055	
40	135	P78640135	
40	240	P78640240	
Spec.		P78699*	

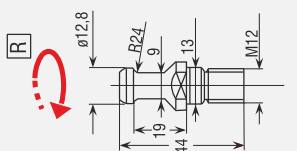
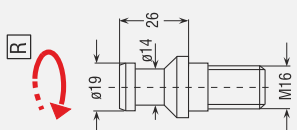
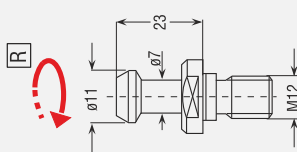
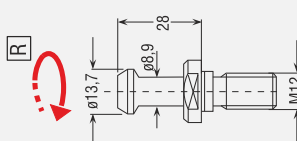
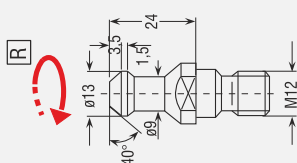
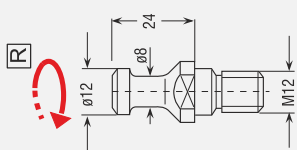
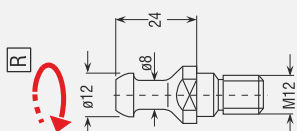
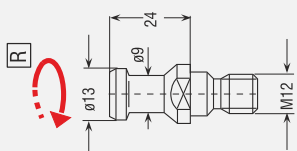
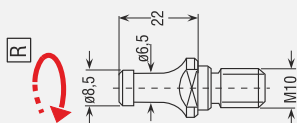

Stroj	Cod.	Cijena
MORBIDELLI- SCM za ISO30	P80001	

Stroj	Cod.	Cijena
IMA-MAKA-REICHENBACHER-WEEKE-CMS- BULLERI-BUSELLATO-COSMEC-COLOMBO za ISO30	P80002	

Stroj	Cod.	Cijena
BIESSE za ISO30	P80003	

Stroj	Cod.	Cijena
BIESSE < 9/92 za ISO30	P80004	

Stroj	Cod.	Cijena
ALBERTI-MASTERWOOD za ISO30	P80005	

Stroj	Cod.	Cijena
HEIAN za ISO30	P80006	

Stroj	Cod.	Cijena
SHODA za ISO30	P80007	

Stroj	Cod.	Cijena
IMA-MAKA-REICHENBACHER-COSMEC za ISO40	P80008	

Stroj	Cod.	Cijena
CMS	P80009	

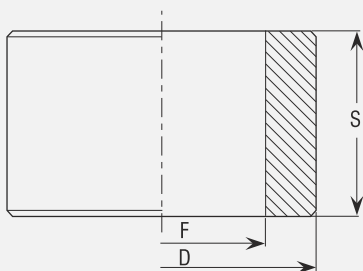

Koristi se na alatima kako bi se reducirao provrt alata s veće dimenzije na manju.

D	F	S	Cod.	Cijena
30	20	2	B02030202	
30	25	2	B02030252	
32	30	2	B02032302	
35	30	2	B02035302	
35	30	5	B02035305	
35	30	10	B020353010	
35	30	15	B020353015	
35	30	20	B020353020	
35	30	25	B020353025	
35	30	30	B020353030	
40	30	2	B02040302	
40	30	5	B02040305	
40	30	10	B020403010	
40	30	15	B020403015	
40	30	20	B020403020	
40	30	25	B020403025	
40	30	30	B020403030	
40	35	2	B02040352	
40	35	5	B02040355	
40	35	10	B020403510	
40	35	15	B020403515	
40	35	20	B020403520	
40	35	25	B020403525	
40	35	30	B020403530	
50	30	5	B02050305	
50	30	10	B020503010	
50	30	15	B020503015	
50	30	20	B020503020	
50	30	25	B020503025	
50	30	30	B020503030	
50	35	10	B020503510	
50	35	15	B020503515	
50	35	20	B020503520	
50	35	25	B020503525	
50	35	30	B020503530	
50	40	10	B020504010	
50	40	15	B020504015	
50	40	20	B020504020	
50	40	25	B020504025	
50	40	30	B020504030	
Spec.			B02099*	

B030

Reducir prsten s prirubnicom i maticom

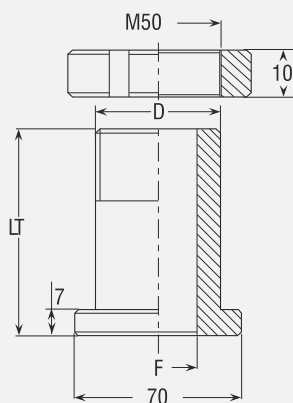

Koristi se za slaganje setova alata.

D	F	LT	Cod. L	Cijena	Cod. R	Cijena
≤ 50	≤ 40	100	B030100L		B030100R	
≤ 50	≤ 40	150	B030150L		B030150R	
≤ 50	≤ 40	200	B030200L		B030200R	
Spec.			B03099L*		B03099R*	

B040

Reducir prsten s prirubnicom

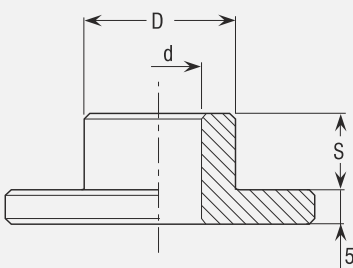

Koristi se na alatima kako bi se reducirao provrt alata s veće dimenzije na manju.

D	d	S	Cod.	Cijena
35	30	10	B040353010	
35	30	15	B040353015	
35	30	20	B040353020	
40	30	10	B040403010	
40	30	15	B040403015	
40	30	20	B040403020	
40	35	10	B040403510	
40	35	15	B040403515	
40	35	20	B040403520	
50	30	10	B040503010	
50	30	15	B040503015	
50	30	20	B040503020	
50	35	10	B040503510	
50	35	15	B040503515	
50	35	20	B040503520	
50	40	10	B040504010	
50	40	15	B040504015	
50	40	20	B040504020	
Spec.			B04099*	

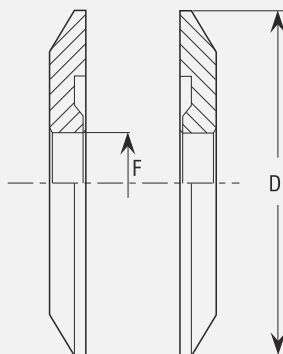
B050**Prirubnica za stezanje kružnih pila**

Koristi se za stezanje kružnih pila na strojevima.

D	F	Cod.	Cijena
100	30	B05010030	
125	30	B05012530	
100	35	B05010035	
125	35	B05012535	
100	40	B05010040	
125	40	B05012540	
100	50	B05010050	
125	50	B05012550	
Spec.		B05099*	

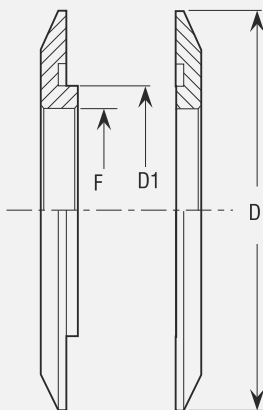
B060**Prirubnica za stezanje kružnih pila sa smanjenim promjerom**

Koristi se za stezanje kružnih pila na strojevima.

D	Cod.	Cijena
100	B060100	
125	B060125	
Spec.	B06099*	

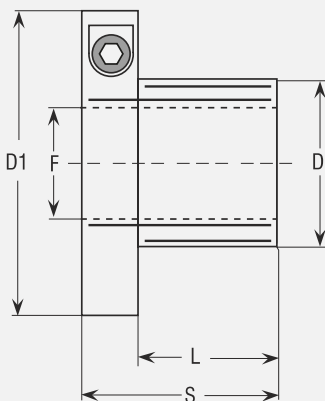

Za prihvat alata s provrtom.
Duplo hidro stezanje (stezanje osovine stroja i alata).

Hidro stezanje se pokreće pomoću odvijača

D1	S	F	D	L	Cod.	Cijena
100	75	40	50	55	B110B5007540	
102	75	40	60	55	B110B6007540	
108	95	40	60	75	B110B6009540	
108	115	40	60	95	B110B6011540	
114	140	40	60	115	B110B6014040	
102	75	50	60	55	B110B6007550	
108	95	50	60	75	B110B6009550	
108	115	50	60	95	B110B6011550	
114	140	50	60	115	B110B6014050	
Spec.					B110B99*	

Hidro stezanje se pokreće pomoću pumpe

D1	S	F	D	L	Cod.	Cijena
93	115	40	60	95	B110B6011540	
93	215	40	60	195	B110B6021540	
93	140	50	60	120	B110B6014050*	
93	190	50	60	170	B110B6019050	
93	230	50	60	210	B110B6023050	
Spec.					B110B99*	



Odvijač



Pumpa

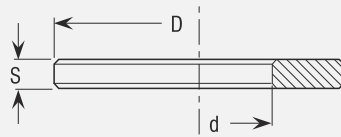

Distantni prsten koristi se kod sklopova alata. Napravljen je od visoko kvalitetnog čelika.

Ostale dimenzije po narudžbi.

d	S	D	Cod.	Cijena
12	0,1	24	A0101201	
12	0,2	24	A0101202	
12	0,5	24	A0101205	
12	1	24	A010121	
16	0,1	30	A0101601	
16	0,2	30	A0101602	
16	0,5	30	A0101605	
16	1	30	A010161	
20	0,1	35	A0102001	
20	0,2	35	A0102002	
20	0,5	35	A0102005	
20	1	35	A010201	
25	0,1	40	A0102501	
25	0,2	40	A0102502	
25	0,5	40	A0102505	
25	1	40	A010251	
30	0,1	50	A0103001	
30	0,2	50	A0103002	
30	0,5	50	A0103005	
30	1	50	A010301	
30	2	50	A010302	
30	3	50	A010303	
30	4	50	A010304	
30	5	50	A010305	
30	6	50	A010306	
30	7	50	A010307	
30	8	50	A010308	
30	9	50	A010309	
30	10	50	A0103010	
30	12	50	A0103012	
30	15	50	A0103015	
30	20	50	A0103020	
35	0,1	55	A0103501	
35	0,2	55	A0103502	
35	0,5	55	A0103505	
35	1	55	A010351	
35	2	55	A010352	
35	3	55	A010353	
35	4	55	A010354	
35	5	55	A010355	

d	S	D	Cod.	Cijena
35	6	55	A010356	
35	7	55	A010357	
35	8	55	A010358	
35	9	55	A010359	
35	10	55	A0103510	
35	12	55	A0103512	
35	15	55	A0103515	
35	20	55	A0103520	
40	0,1	60	A0104001	
40	0,2	60	A0104002	
40	0,5	60	A0104005	
40	1	60	A010401	
40	2	60	A010402	
40	3	60	A010403	
40	4	60	A010404	
40	5	60	A010405	
40	6	60	A010406	
40	7	60	A010407	
40	8	60	A010408	
40	9	60	A010409	
40	10	60	A0104010	
40	12	60	A0104012	
40	15	60	A0104015	
40	20	60	A0104020	
50	0,1	70	A0105001	
50	0,2	70	A0105002	
50	0,5	70	A0105005	
50	1	70	A010501	
50	2	70	A010502	
50	3	70	A010503	
50	4	70	A010504	
50	5	70	A010505	
50	6	70	A010506	
50	7	70	A010507	
50	8	70	A010508	
50	9	70	A010509	
50	10	70	A0105010	
50	12	70	A0105012	
50	15	70	A0105015	
50	20	70	A0105020	
Spec.			A01099*	

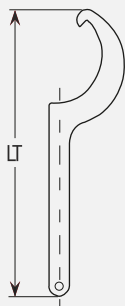
CH**Kukasti ključ**

S	LT	Cod.	Cijena
52-55	205	CH052	
58-62	240	CH058	
Spec.		CH99*	

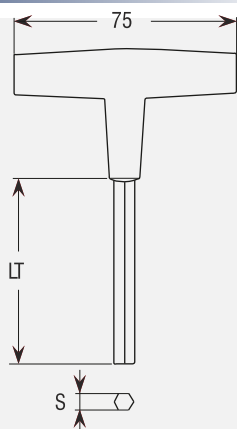
CHET**Šesterokutni odvijač s "T" ručkom, "IMBUS"**

S	LT	Cod.	Cijena
2,5	90	CHET025	
3	90	CHET03	
4	100	CHET04	
5	110	CHET05	
6	110	CHET06	
6	200	CHET06H	
8	200	CHET08H	
10	200	CHET10H	
Spec.		CHET99*	

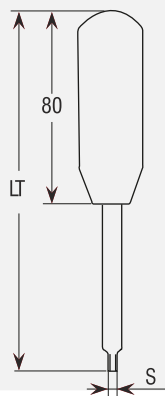
CHTC**Torx odvijač s ručkom**

S	LT	Cod.	Cijena
T9	130	CHTC09	
T10	150	CHTC10	
T15	160	CHTC15	
T20	180	CHTC20	
Spec.		CHTC99*	

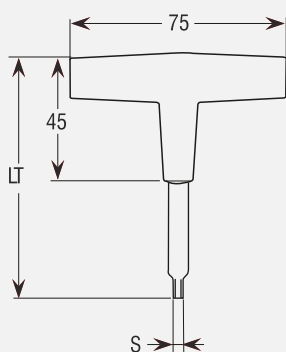
CHTT**Torx odvijač s "T" ručkom**

S	LT	Cod.	Cijena
T9	90	CHTT09	
T10	95	CHTT10	
T15	95	CHTT15	
T20	150	CHTT20	
T25	150	CHTT25	
Spec.		CHTT99*	